

WWW.NONOX.HU

ÉPÜLETVASALATOK,
BÉKAZÁRAK



NONOX[®]

KORRÓZIÓÁLLÓ ACÉLTERMÉKEK

Mit is takar a **NONOX** márkanév?

Korrózióálló acélból készült kötés- és rögzítéstechnikai alkatrészek komplett palettája. Ilyenek pl. a csavarok, anyák, alátétek, szegecsek, dűbelek, békazárak, sodronyok, láncok, hajóveretek és ezek szerelvényei stb.

Mik a közös jellemzői ezeknek a termékeknek?

1. Alapanyagukat tekintve:

- A legkorszerűbb ausztenites szerkezetű nemesacél ötvözetek.
- Megfelelnek a nemzetközi normáknak, az egész világon alkalmazzák őket.
- Nagy mértékben ellenállnak az agresszív folyadékoknak, gőzöknek és gázoknak.
- Hegeszthetők, polírozhatók.
- Felhasználhatók az élelmiszeriparban, a vonatkozó élelmiszeripari előírásoknak megfelelnek.
- Az egész világon előírások rendelkeznek továbbá vegyiparban, energiaiparban, az egészségügyben stb. történő alkalmazásukról.

2. Maguk a **NONOX termékek:**

- Nagyon magas szintű gyártási technológia, és folyamatos minőségi kontroll mellett készülnek.
- A minőségbiztosítási lánc az alapanyaggyártástól egészen a felhasználásig terjed.
- Élettartamuk sokkal hosszabb, mint a hasonló szénacél, felületkezelt termékeké.
- Bár mechanikai és felhasználási tulajdonságaik eltérnek, szilárdságuk megközelíti a leggyakrabban használt szénacél termékek szilárdsági értékeit.
- Előnyös tulajdonságaik miatt egyre elterjedtebbek az építőiparban: kültéren időjárásállóságuk, nagy teherbírásuk és élettartamuk, beltéren az előbbieken kívül a kor ízlésének megfelelő esztétikai megjelenésük miatt is.
- Előszeretettel alkalmazzák a műszeriparban is, mert bizonyos ötvözetek antimagnetikus tulajdonsággal is rendelkeznek.
- Rozsdamentes szerkezeti munkák el sem képzelhetők megfelelő nemesacél kötőelemek és kiegészítők felhasználása nélkül, mivel ezek az anyagok nem alkalmazhatók szénacélokkal keverten.

Keresse a NONOX márkajelzést!

Mi garantáljuk, hogy mindig az igényeinek leginkább megfelelő nemesacél termékeket szállítjuk Önnek!



Keskeny zsanér / Hinge, narrow

Rendelési szám Order number	Méretek / Size (mm)			kb. kg/100 db appr. kg/100 pcs	Furatszám Holes	
	A	B	Vastagság Thickness		db pcs	Ø mm
MV 10501 030	30	22	0,8	0,8	4	2
MV 10501 040	40	26	0,9	1,2	4	2,5
MV 10501 050	50	31	1,0	2,1	6	3
MV 10501 060	60	34	1,2	3,0	6	3
MV 10501 080	80	41	1,5	5,4	6	3,5
MV 10501 100	100	52	1,5	8,8	8	4

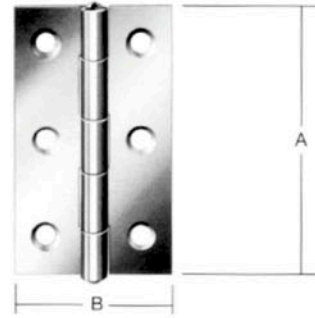

Félgömbfejű,
rozsdamentes
stífttel szegecsel

Riveted by button
head, stainless
steel pins



Téglalap alakú zsanér / Hinge, rectangle

Rendelési szám Order number	Méretek / Size (mm)			kb. kg/100 db appr. kg/100 pcs	Furatszám Holes	
	A	B	Vastagság Thickness		db pcs	Ø mm
MV 10502 040	40	32	0,9	1,4	4	2,5
MV 10502 050	50	39	1,0	2,6	6	3
MV 10502 060	60	46	1,2	4,1	6	3
MV 10502 080	80	58	1,5	7,3	6	3,5
MV 10502 100	100	72	1,5	12,0	8	4,5

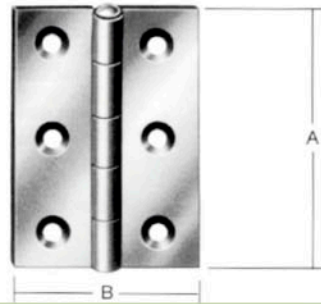

Félgömbfejű,
rozsdamentes
stífttel szegecsel

Riveted by button
head, stainless
steel pins



Négyzetes zsanér / Hinge, square

Rendelési szám Order number	Méretek / Size (mm)			kb. kg/100 db appr. kg/100 pcs	Furatszám Holes	
	A	B	Vastagság Thickness		db pcs	Ø mm
MV 10503 030	30	30	0,8	1,3	4	2,5
MV 10503 040	40	40	0,9	1,8	4	2,5
MV 10503 050	50	50	1,0	3,4	6	3
MV 10503 060	60	60	1,25	4,6	6	3
MV 10503 070	70	70	1,25	5,8	6	3,5
MV 10503 080	80	80	1,5	9,8	6	3,5
MV 10503 100	100	100	1,5	15,0	8	4

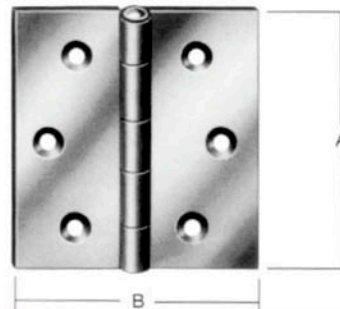

Félgömbfejű,
rozsdamentes
stífttel szegecsel

Riveted by button
head, stainless
steel pins



Széles zsanér / Hinge, wide

Rendelési szám Order number	Méretek / Size (mm)			kb. kg/100 db appr. kg/100 pcs	Furatszám Holes	
	A	B	Vastagság Thickness		db pcs	Ø mm
MV 10504 030	30	45	1,0	1,4	6	3
MV 10504 040	40	60	0,9	2,4	6	3
MV 10504 050	50	75	1,2	4,5	8	3,5
MV 10504 060	60	90	1,2	6,6	8	3,5
MV 10504 080	80	120	1,5	14,0	8	4

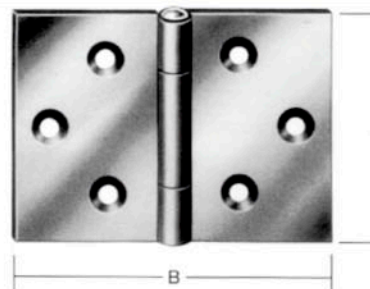

Félgömbfejű,
rozsdamentes
stífttel szegecsel

Riveted by button
head, stainless
steel pins



Széles asztal csuklópánt / Hinge to table, wide

Rendelési szám Order number	Méretek / Size (mm)			kb. kg/100 db appr. kg/100 pcs	Furatszám Holes	
	A	B	Vastagság Thickness		db pcs	Ø mm
MV 10505 080	80	28	1,0	2,7	6	3
MV 10505 100	100	32	1,2	3,7	6	3
MV 10505 120	120	33	1,2	4,6	8	3,5
MV 10505 140	140	34	1,5	6,5	8	3,5
MV 10505 160	160	37	1,5	8,3	8	3,5

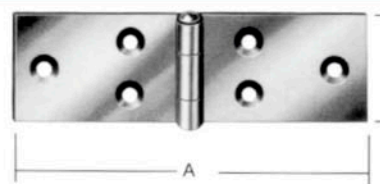

Félgömbfejű,
rozsdamentes
stífttel szegecsel

Riveted by button
head, stainless
steel pins



ÉPÜLETVASALATOK

Négyzetes, ipari zsanér / Industrial hinge, square

Rendelési szám	Méretek / Size (mm)			kb. kg/100 db	Furatszám Holes	
Order number	A	B	Vastagság Thickness	appr. kg/100 pcs	db pcs	Ø mm
MV 10613 060	60	60	1,5	8,0	6	4,0

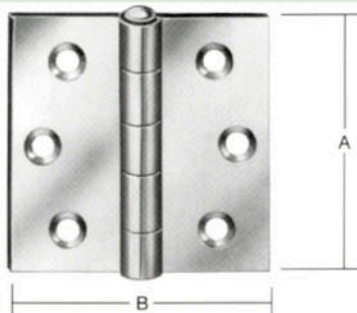

Félgömbfejű, rozsdamentes, stifttel szegecselt

Riveted by button head, stainless steel pins



Négyzetes, bontható, ipari zsanér Industrial hinge, unfolded, square

Rendelési szám	Méretek / Size (mm)			kb. kg/100 db	Furatszám Holes	
Order number	A	B	Vastagság Thickness	appr. kg/100 pcs	db pcs	Ø mm
MV 10614 060	60	60	1,5	8	6	4
MV 10614 075	75	75	1,8	12	6	4
MV 10614 090	90	90	1,8	18	6	4,5

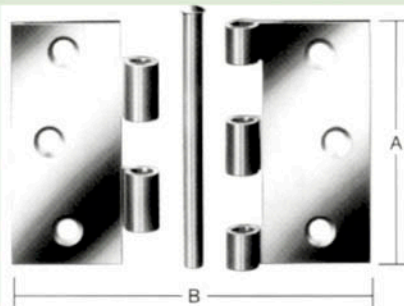

Kihúzható, rozsdamentes, félgömbfejű, stifttel rögzítve

Riveted by button head, stainless steel, pull-out pins



Kerekített, bontható, ipari zsanér Industrial hinge, unfolded, rounded

Rendelési szám	Méretek / Size (mm)			kb. kg/100 db	Furatszám Holes	
Order number	A	B	Vastagság Thickness	appr. kg/100 pcs	db pcs	Ø mm
MV 10617 075	75	75	1,8	12	6	4

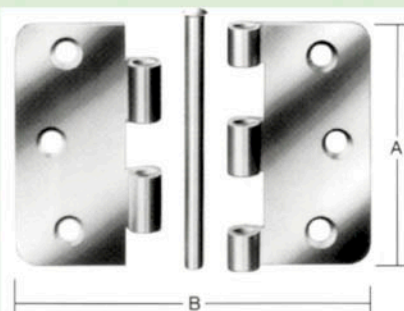

Kihúzható, rozsdamentes, félgömbfejű, stifttel rögzítve

Riveted by button head, stainless steel, pull-out pins



Ajtózsánér / Door hinge

Rendelési szám	Méretek / Size (mm)			kb. kg/100 db	Furatszám Holes	
Order number	A	B	Vastagság Thickness	appr. kg/100 pcs	db pcs	Ø mm
MV 10870 075	75	75	2,5	17	6	4
MV 10870 090	90	85	2,5	21	6	4,5

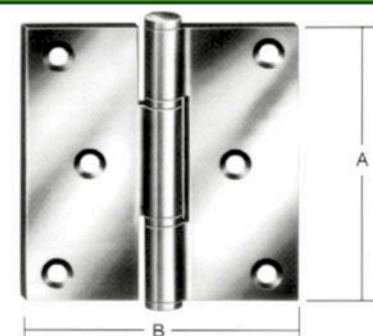

Hengeres fejű, rozsdamentes, stifttel és közbetétel szegecselt

Riveted by cylinder head, stainless steel pin and insertion piece



Leakasztható ajtózsánér / Door hinge, unhooked

Rendelési szám	Méretek / Size (mm)			kb. kg/100 db	Furatszám Holes	
Order number	A	B	Vastagság Thickness	appr. kg/100 pcs	db pcs	Ø mm
MV 10871 090	90	90	2,5	22	6	4
<i>bal</i>						
MV 10872 090	90	90	2,5	22	6	4
<i>jobb</i>						

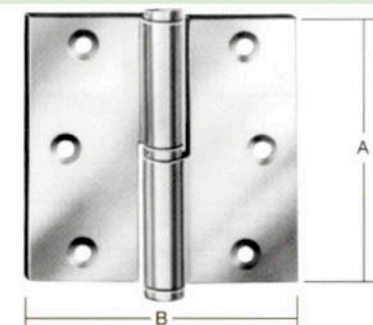

Hengeres fejű, rozsdamentes, stifttel és közbetétel szegecselt csiszolt felületű

Riveted by cylinder head, stainless steel pin and insertion piece Polished



Keskeny zsanér / Hinge, narrow

Rendelési szám	Méretek / Size (mm)			kb. kg/100 db	Furatszám Holes	
Order number	A	B	Vastagság Thickness	appr. kg/100 pcs	db pcs	Ø mm
MV 10501 050 U	50	31	1,0	2,1	-	-

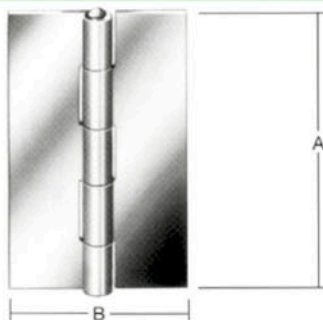

Félgömbfejű, rozsdamentes, stifttel szegecselt

Riveted by button head, stainless steel pins



Téglalap alakú zsanér / Hinge, rectangle

Rendelési szám	Méretek / Size (mm)			kb. kg/100 db	Furatszám Holes	
Order number	A	B	Vastagság Thickness	appr. kg/100 pcs	db pcs	Ø mm
MV 10502 060 U	60	46	1,2	4,1	-	-

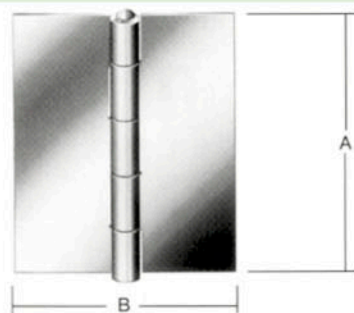

Félgömbfejű, rozsdamentes, stifttel szegecselt

Riveted by button head, stainless steel pins



Négyzetes zsanér / Hinge, square

Rendelési szám	Méretek / Size (mm)			kb. kg/100 db	Furatszám Holes	
Order number	A	B	Vastagság Thickness	appr. kg/100 pcs	db pcs	Ø mm
MV 10503 040 U	40	40	0,9	1,8	-	-

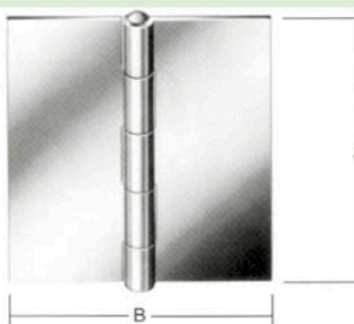

Félgömbfejű, rozsdamentes, stifttel szegecselt

Riveted by button head, stainless steel pins



Széles zsanér / Hinge, wide

Rendelési szám	Méretek / Size (mm)			kb. kg/100 db	Furatszám Holes	
Order number	A	B	Vastagság Thickness	appr. kg/100 pcs	db pcs	Ø mm
MV 10504 060 U	60	90	1,2	6,6	-	-

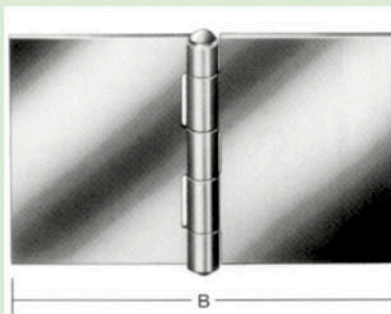

Félgömbfejű, rozsdamentes, stifttel szegecselt

Riveted by button head, stainless steel pins



Széles asztal csuklópánt / Hinge to table, wide

Rendelési szám	Méretek / Size (mm)			kb. kg/100 db	Furatszám Holes	
Order number	A	B	Vastagság Thickness	appr. kg/100 pcs	db pcs	Ø mm
MV 10505 100 U	100	32	1,2	3,7	-	-

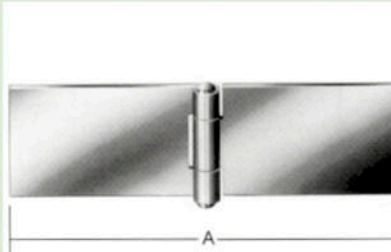

Félgömbfejű, rozsdamentes, stifttel szegecselt

Riveted by button head, stainless steel pins



ÉPÜLETVASALATOK

Négyzetes, ipari zsanér / Industrial hinge, square

Rendelési szám	Méretek / Size (mm)			kb. kg/100 db	Furatszám Holes	
Order number	A	B	Vastagság Thickness	appr. kg/100 pcs	db pcs	Ø mm
MV 10613 075 U	75	75	1,8	11,9	-	-

Négyzetes, bontható, ipari zsanér Industrial hinge, unfolded, square

Rendelési szám	Méretek / Size (mm)			kb. kg/100 db	Furatszám Holes	
Order number	A	B	Vastagság Thickness	appr. kg/100 pcs	db pcs	Ø mm
MV 10614 060 U	60	60	1,5	8	-	-
MV 10617 075 U	75	75	1,8	12	-	-

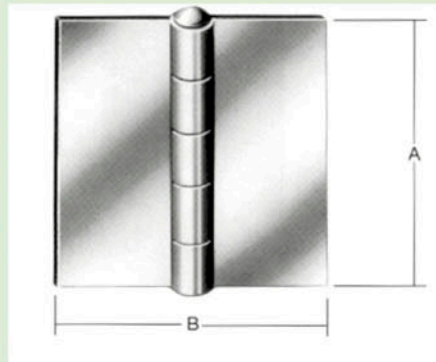

Félgömbfejű,
rozsdamentes,
stifttel szegecselt

Riveted by button
head, stainless
steel pins

Kihúzható,
rozsdamentes,
félgömbfejű,
rozsdamentes
stifttel rögzítve

Riveted by button
head, stainless
steel
pull-out pins



Ajtózsánér / Door hinge

Rendelési szám	Méretek / Size (mm)			kb. kg/100 db	Furatszám Holes	
Order number	A	B	Vastagság Thickness	appr. kg/100 pcs	db pcs	Ø mm
MV 10870 090 U	90	85	2,5	21	-	-

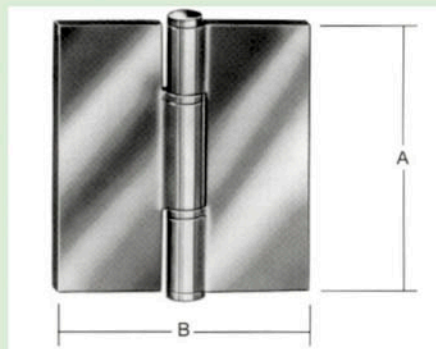

Félgömbfejű,
rozsdamentes,
stifttel szegecselt

Riveted by cylinder
head, stainless steel
pin



"Csepp" profilú diópánt / Drop shaped diópánt???

Rendelési szám	Méretek / Size (mm)			kb. kg/100 db	Furatszám Holes	
Order number	A	B	Vastagság Thickness	appr. kg/100 pcs	db pcs	Ø mm
MV 11001 080	80	16	13	9,5	-	-



Hengeresfejű,
rozsdamentes,
stifttel és
közbetéttel
szegecselt
Fényes felületű

Riveted by cylinder
head, stainless steel
pin and insertion
piece
Satin finish

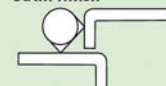

Furatmentes zongorazsanér Continuous hinge, without holes

Rendelési szám Order number	Méretek / Size (mm)			kb. kg/100 db appr. kg/100 pcs	Furatszám Holes	
	A	B	Vastagság Thickness		db pcs	Ø mm
MV 10450 032 U	32	3500	0,7	1,7	-	-
MV 10450 321 U	32	3500	1,0	1,7	-	-

Furatmentes, ipari zongorazsanér Industrial continuous hinge, without holes

Rendelési szám Order number	Méretek / Size (mm)			kb. kg/100 db appr. kg/100 pcs	Furatszám Holes	
	A	B	Vastagság Thickness		db pcs	Ø mm
MV 10460 003	32	3500	1,5	3,0	-	-
MV 10460 004	40	3500	1,5	3,0	-	-
MV 10460 005	50	3500	1,5	3,0	-	-
MV 10460 050	50	3500	2,0	6,0	-	-
MV 10460 060	60	3500	2,0	6,0	-	-

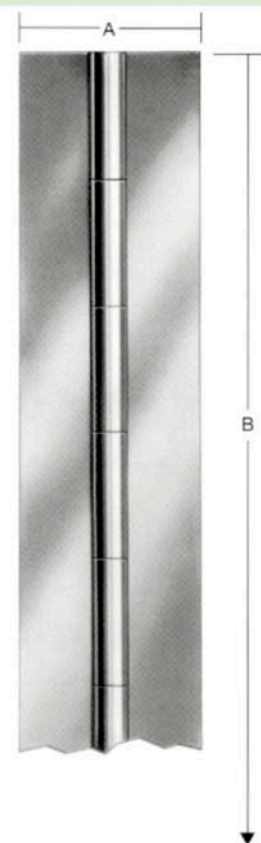

Fényesre hengerelt
Polished rolled

Fényesre hengerelt
Polished rolled

Zongorazsanér / Continuous hinge

Rendelési szám Order number	Méretek / Size (mm)			kb. kg/100 db appr. kg/100 pcs	Furatszám Holes	
	A	B	Vastagság Thickness		db pcs	Ø mm
MV 10450 032	32	3500	0,7	1,7	-	2,5
MV 10450 040	40	3500	0,8	1,7	-	2,5

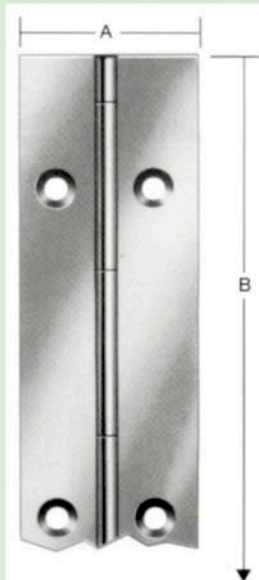

Fényesre hengerelt
Polished rolled

Leakasztható bútorzsanér / Furniture hinge, unhooked

Rendelési szám Order number	Méretek / Size (mm)			kb. kg/100 db appr. kg/100 pcs	Furatszám Holes	
	A	B	Vastagság Thickness		db pcs	Ø mm
MV 10620 050 <i>bal</i>	50	40	1,5	3,9	6	3
MV 10620 051 <i>jobb</i>	50	40	1,5	3,9	6	3

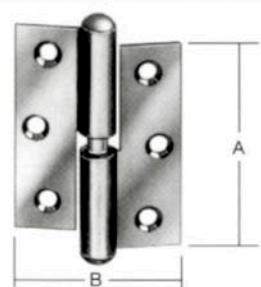

Fényesre csiszolt
Polished

ÉPÜLETVASALATOK

Felemás trapéz alakú zsanér / Hinge, unmatched trapezoid

Rendelési szám	Méretek / Size (mm)			kb. kg/100 db	Furatszám Holes	
Order number	A	B	Vastagság Thickness	appr. kg/100 pcs	db pcs	Ø mm
MV 10043 035	35	40	1,5	3,2	5	3
	20					



Rejtettfejű, rozsdamentes stifttel

With covert headed stainless steel pin



Trapéz alakú zsanér / Hinge, trapezoid

Rendelési szám	Méretek / Size (mm)			kb. kg/100 db	Furatszám Holes	
Order number	A	B	Vastagság Thickness	appr. kg/100 pcs	db pcs	Ø mm
MV 10046 070	70	40	1,5	3,5	6	3

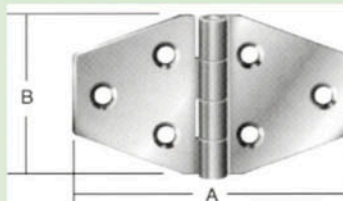

Rejtettfejű, rozsdamentes stifttel

With covert headed stainless steel pin



Nyújtott, felemás trapéz alakú zsanér / Hinge, unmatched long trapezoid

Rendelési szám	Méretek / Size (mm)			kb. kg/100 db	Furatszám Holes	
Order number	A	B	Vastagság Thickness	appr. kg/100 pcs	db pcs	Ø mm
MV 10043 080	80	37	1,5	4,5	6	4
	30					

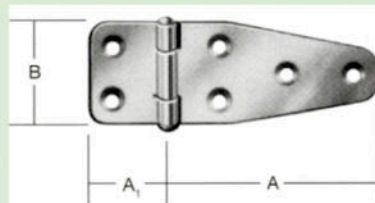

Félgömbfejű, rozsdamentes stifttel szegecsel

Riveted by button head, stainless steel pins



Nyújtott trapéz alakú zsanér / Hinge, long trapezoid

Rendelési szám	Méretek / Size (mm)			kb. kg/100 db	Furatszám Holes	
Order number	A	B	Vastagság Thickness	appr. kg/100 pcs	db pcs	Ø mm
MV 10046 160	160	37	1,5	6	8	4

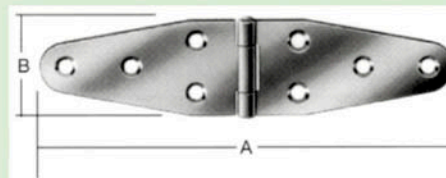

Félgömbfejű, rozsdamentes stifttel szegecsel

Riveted by button head, stainless steel pins



Széles ládapánt / Box band, wide

Rendelési szám	Méretek / Size (mm)			kb. kg/100 db	Furatszám Holes	
Order number	A	B	Vastagság Thickness	appr. kg/100 pcs	db pcs	Ø mm
MV 10028 160	160	35	2	12	8	4
MV 10028 200	200	35	2	15	8	4

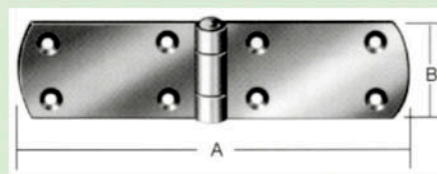

Félgömbfejű, rozsdamentes stifttel szegecsel

Riveted by button head, stainless steel pins



Ládapánt / Box band

Rendelési szám	Méretek / Size (mm)			kb. kg/100 db	Furatszám Holes	
Order number	A	B	Vastagság Thickness	appr. kg/100 pcs	db pcs	Ø mm
MV 10096 200	200	35	2	15	4	5

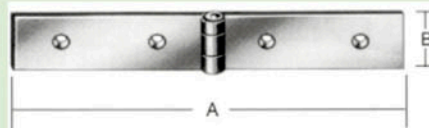

Rozsdamentes stifttel szegecsel

Riveted by stainless steel pin



Ablak retesz / Gate valve to windows

Rendelési szám Order number	Méretek / Size (mm)			kb. kg/100 db appr. kg/100 pcs	Furatszám Holes	
	A	B	Vastagság Thickness		db pcs	Ø mm
MV 10102 080	80	30	1,0	5,5	5	3,0
MV 10102 100	100	5	1,0	8,2	5	3,0

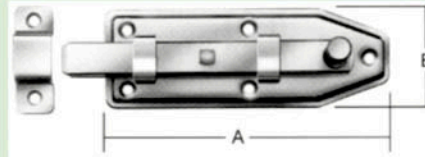

Félgömbfejű,
rozsdamentes,
stífttel szegecselt

Riveted by button
head, stainless
steel pins

Lakolható tolozár ajtóhoz / Gate valve to doors, hasped

Rendelési szám Order number	Méretek / Size (mm)			kb. kg/100 db appr. kg/100 pcs	Furatszám Holes	
	A	B	Vastagság Thickness		db pcs	Ø mm
MV 10105 120	120	56	1,75	17	6	4
MV 10105 140	140	56	1,75	26	6	4

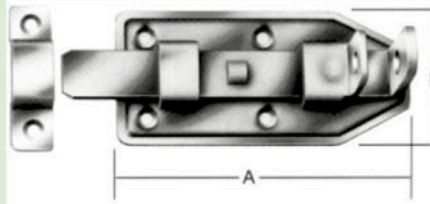

Szögletes retesz
füllel

Square gate valve
with loop

Gombos tolozár / Gate valve with knobs

Rendelési szám Order number	Méretek / Size (mm)			kb. kg/100 db appr. kg/100 pcs	Furatszám Holes	
	A	B	Vastagság Thickness		db pcs	Ø mm
MV 10107 120	120	56	1,75	17	6	4
MV 10107 140	140	56	1,75	26	6	4

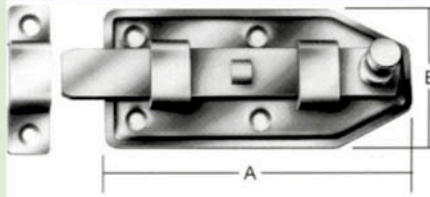

Szögletes retesz
füllel

Square gate valve
with loop

Hengeres csapú, gombos rigli / Gate valve with knobs and cylindrical

Rendelési szám Order number	Méretek / Size (mm)			kb. kg/100 db appr. kg/100 pcs	Furatszám Holes	
	A	B	Vastagság Thickness		db pcs	Ø mm
MV 10227 080	50	36	1/2	10,4	6	4,0
	30					
			henger 10			

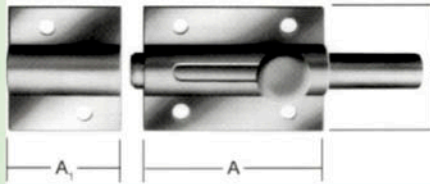

Hengeres retesz
füllel

Cylindric gate valve
with loop

Bútor rigli / Gate valve to furniture

Rendelési szám Order number	Méretek / Size (mm)			kb. kg/100 db appr. kg/100 pcs	Furatszám Holes	
	A	B	Vastagság Thickness		db pcs	Ø mm
MV 10222 080	80	22	1,0	4,0	4	2,5
	100					

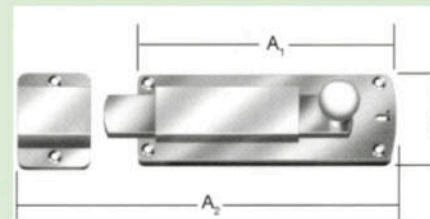

Szögletes retesz
füllel

Square gate valve
with loop

ÉPÜLETVASALATOK

Besüllyeszthető karikafogantyú / Circle handgrip

Rendelési szám Order number	Méretek / Size (mm)			Ø	kb. kg/100 db appr. kg/100 pcs	Furatszám Holes	
	A	B	Vastagság Thickness			db pcs	Ø mm
MV 11330 065	65	55	1	-	4,8	4	3

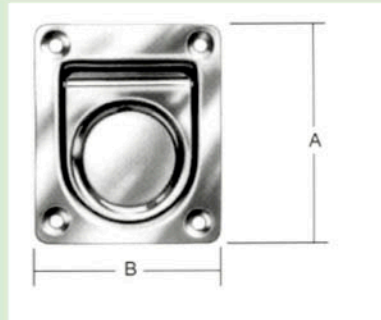

Besüllyeszthető ládafogantyú / Handgrip to boxes

Rendelési szám Order number	Méretek / Size (mm)			Ø	kb. kg/100 db appr. kg/100 pcs	Furatszám Holes	
	A	B	Vastagság Thickness			db pcs	Ø mm
MV 10190 005	170	105	2,0	10	50	4	5,0

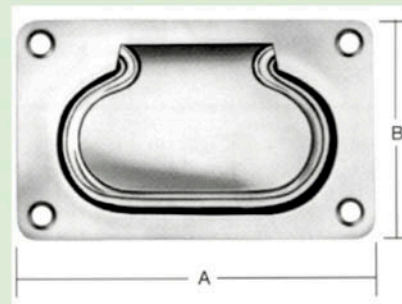

Lekerekített
sarokkal
with rounded
angles

Szögletes ládafogantyú / Square handgrip

Rendelési szám Order number	Méretek / Size (mm)			Ø	kb. kg/100 db appr. kg/100 pcs	Furatszám Holes	
	A	B	Vastagság Thickness			db pcs	Ø mm
MV 11328 100	100	80	1,5	7,5	18	4	4,5

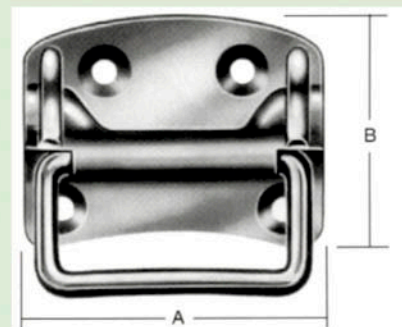

DIN 3136

Hajlított lemezfogantyú / Curved plate handgrip

Rendelési szám Order number	Méretek / Size (mm)			Ø	kb. kg/100 db appr. kg/100 pcs	Furatszám Holes	
	A	B	Vastagság Thickness			db pcs	Ø mm
MV 10193 160	160	20	4	-	11,8	4	4,5
MV 10193 200	200	20	4	-	14,4	4	4,5

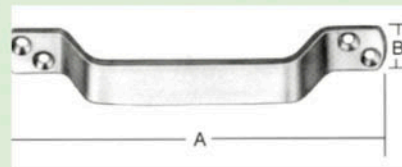

Perforált NONOX szerelőszalag / Perforated NONOX assembly

Rendelési szám Order number	Méretek Size (mm)	1 db tekercs hossza Length of 1 roll
MV 11401 016	16 x 0,9	3 m
MV 11403 016	16 x 0,9	10 m



Ajtó zsanér Door hinges

Art. Nr. 8231
A4



L	B	S
76	38	4
100	38	4

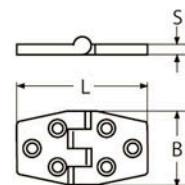

Ajtó zsanér Door hinges

Art. Nr. 8234
A4



L	B	S
56	38	4
76	38	4

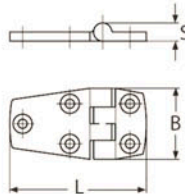

"Szíj zsanér" Strap hinges

Art. Nr. 8235
A4



L	B	S
100	25	4

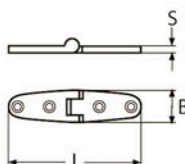

"Szíj zsanér" Strap hinges

Art. Nr. 8236
A4



L	B	S
160	27	4

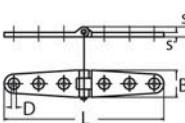

Kivetőzsanér Offset hinges

Art. Nr. 8237
A4



L	B	S	S1
56	38	4	9,5
76	38	4	9,5

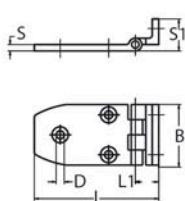

Zsanér Butt hinges

Art. Nr. 8233
A4



L	B	S
38	38	4
50	50	4

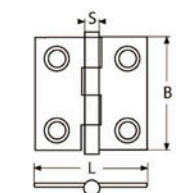

Leemelhető motorboxzsanér Take-apart motor box hinges

Art. Nr. 8239
A4



L	B	S
90	38	3

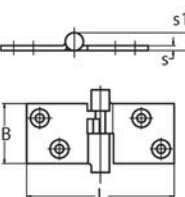

ÉPÜLETVASALATOK

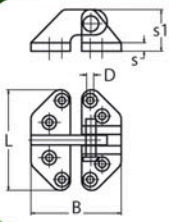

L	B	S
74	65	6



Fedélzeti-nyílásfedélzsanér
Hatch hinges standard
 Art. Nr. 8238
 A4

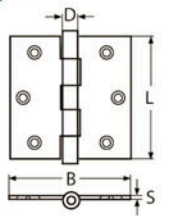

D	L	B	S
10	75	75	2



Zsanér Hinges heavy duty
 Art. Nr. 8514
 A2

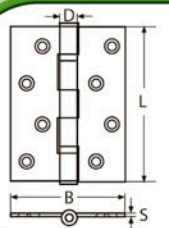

D	L	B	S
11	100	75	2,5

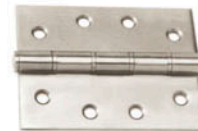

Zsanér Hinges heavy duty
 Art. Nr. 8513
 A2

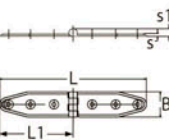

L	L1	B	D	S	S1
160	80	28	4,5	3	8



Zsanér Hinge
 Art. Nr. 8573
 A2

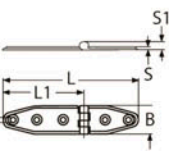

L	L1	B	D	S	S1
133	80	28	4,5	3	8



Zsanér Hinge
 Art. Nr. 8574
 A2

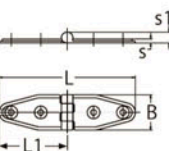

L	L1	B	D	S	S1
105	53	28	4,5	3	8



Zsanér Hinge
 Art. Nr. 8575
 A2

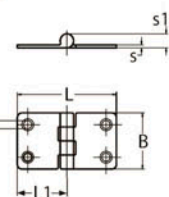

L	L1	B	D	S	S1
38	19	38	5,5	2	9
68	34	38	5,5	2	9



Zsanér Hinge
 Art. Nr. 8569
 A2

**Balos leemelhető
ajtózsánér**
**Door hinges
left two parts**
Art. Nr. 8512
A2



	D	L	B	S
Rechts Right	14	100	80	3
Links Left	14	100	80	3

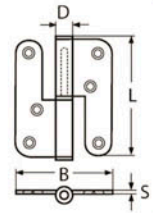

**Zsanér
Hinges**
Art. Nr. 8429
A2



Form	L	B	L1	S	D	S1
Form A	129	40	38	2	5	9
Form B	129	40	38	2	5	9

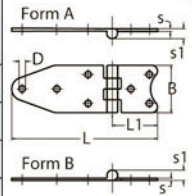

**Zsanér
Hinges**
Art. Nr. 8430
A2



Form	L	B	D	S	S1
Form A	180	40	5	2	9
Form B	180	40	5	2	9

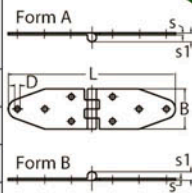

**Zsanér
Hinges**
Art. Nr. 8568
A2



L	L1	B	D	S	S1
58	40	38	5,5	2	9
68	49	38	5,5	2	9

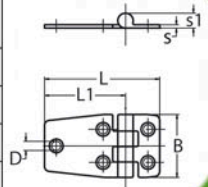

**Zsanér
Hinges**
Art. Nr. 8578
A2



L	L1	B	D	S	S1
87	38	38	5,4	2	9
97	40	38	5,4	2	9

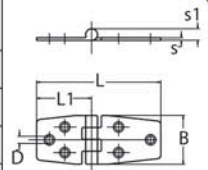

**Zsanér
Hinges**
Art. Nr. 8572
A2



L	L1	B	D	S	S1
75	37,5	38	5,5	2	9

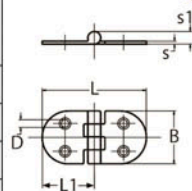

**Zsanér
Hinges**
Art. Nr. 8571
A2



L	L1	B	D	S	S1
110	38	38	5,5	2	9

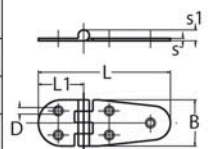

ÉPÜLETVASALATOK

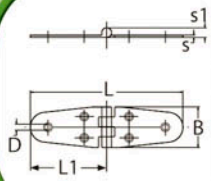

L	L1	B	D	S	S1
145	72,5	38	5,5	2	9



Zsanér Hinge
Art. Nr. 8570
A2

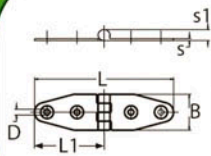

L	L1	B	D	S	S1
100	50	28	5,5	2	9



Zsanér Hinge
Art. Nr. 8576
A2

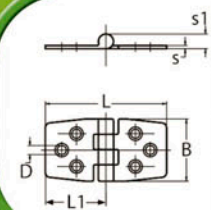

L	L1	B	D	S	S1
75	37,5	38	5,4	2	9
97	48,5	38	5,4	2	9



Zsanér Hinge
Art. Nr. 8577
A2

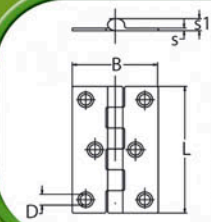

L	B	D	S	S1
50	35	3,3	1,7	8
62	40	3,3	1,7	8
75	48	5,5	1,7	8
100	54	6,6	1,7	8



Zsanér Hinge
Art. Nr. 8567
A2

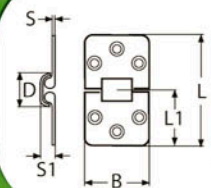

L	L1	B	D	S	S1
70	35	42	6	2,2	7,5



Zsanér Hinge
Art. Nr. 8670
A4

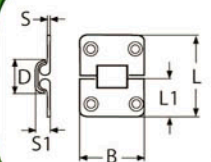

L	L1	B	D	S	S1
52	26	42	6	2,2	7,5



Zsanér Hinge
Art. Nr. 8671
A4

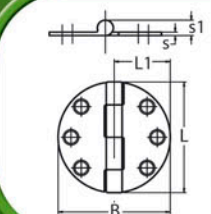

L	L1	B	D	S	S1
65	32,5	65	7,5	2	9



Zsanér Hinge
Art. Nr. 8678
A4

Takart zsanér Covered hinges

Art. Nr. 8676
A4



L	L1	B	D	S	S1
74	37	40	5,5	2	9

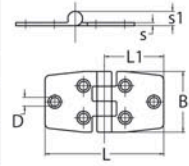

Takart zsanér Covered hinges

Art. Nr. 8677
A4



L	L1	B	D	S	S1	κ
75	37	74	7,5	2	9	

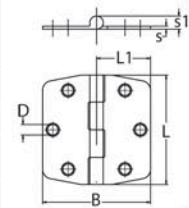

Takart zsanér Covered hinges

Art. Nr. 8675
A4



L	L1	B	D	S	S1
57	18	37	6	2	9

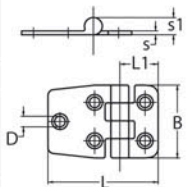

Takart zsanér Covered hinges

Art. Nr. 8674
A4



L	L1	B	D	S	S1
36	18	36	6	2	9

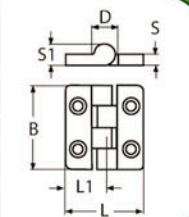

Zongorazsanér Offset hinges

Art. Nr. 8321
A2



Materialstärke tension strength	Gesamtbreite total length	Stangenlänge bar length
0,7	16	3.500
0,7	18	3.500
0,7	20	3.500
0,7	25	3.500
0,7	32	3.500
0,7	40	3.500
1,5	32	2.000
1,5	40	2.000

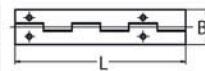

Forgó lakatpánt lakatszettel Swivel hasp



Art. Nr. 8428
A2



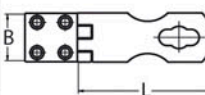

L	B	Box
71	24	5

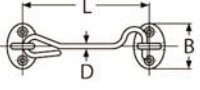

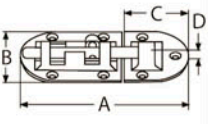

ÉPÜLETVASALATOK

	L	B	D		Ajtókampó Cabin hook Art. Nr. 8650 A4
	50	33	4,4		
	70	33	4,4		
	90	33	4,4		

	L	B		Ajtókampó Cabin hook Art. Nr. 8384 A4
	100	37,5		

	A	B	C	D	Materialstärke tension strength		Retesz Locking hing Art. Nr. 8413 A4
	15	45	30	9,5	2,3		
	36	76	38	9,5	4		

	Länge length	Draht-Ø wire-Ø		Ajtókampó szemescsavarral Gate hooks with eyes Art. Nr. 8318 A2
	80	3,9		
	120	4,4		

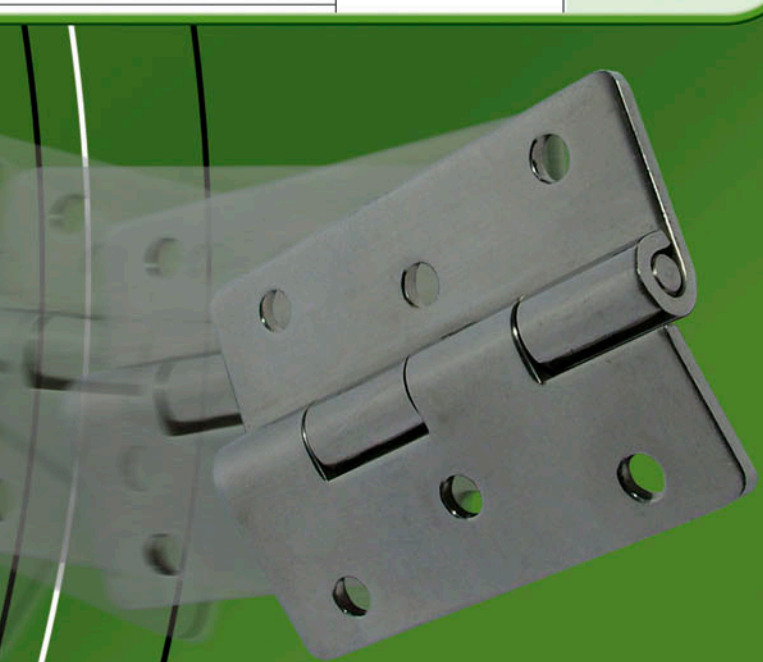

A

B

C

D

E

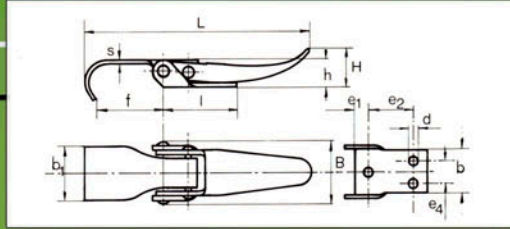

1

2

3

4

5

6

7

BÉKAZÁRAK

Art. nr. 540-10
LBH=110/38/11
A2
Rigid types
Stabil típusok
Ellendarab: C0028

Art. nr. 1540-15
LBH=110/38/24
A2
Rigid types
Stabil típusok
Ellendarab: C0028

Art. nr. 1541-00
LBH=135/47/35
A2
Rigid types
Stabil típusok
Ellendarab: C0028, C0030

Art. nr. 1824-00
LBH=92/32/16
A2
For steel strips and chains
Szalagos rögzítéshez (domború)

Art. nr. 420-20
LBH=200/46/36
A2
Adjustable types
Állítható típusok
Ellendarab: C0028, C0030

Art. nr. 2818-00
LBH=104/54/17
A2
Rigid types
Stabil típusok

Art. nr. 2818-02
LBH=104/54/17
A2
Rigid types
Stabil típusok

Art. nr. 2818-50
LBH=104/27/17
A2
Rigid types
Stabil típusok

Art. nr. 2818-52
LBH=104/27/17
A2
Rigid types
Stabil típusok

Art. nr. 420-00
LBH=200/65/36
A2
Adjustable types
Állítható típusok
Ellendarab: C0028, C0030

Art. nr. 2157 s-20
LBH=110/28/17
A2
Adjustable types
Domború, állítható típus
Ellendarab: C0015

Art. nr. 656-00
LBH=87/23/13
A2
For steel strips and chains
Szalagos rögzítéshez (domború)

Art. nr. 1284-00
LBH=140/30/13
A2
For steel strips and chains
Szalagos rögzítéshez (domború)
Ellendarab: C1284-00, C15-20

Art. nr. 1322-00
LBH=122/22/13
A2
For steel strips and chains
Szalagos rögzítéshez (domború)
Ellendarab: C1322-00

Art. nr. 1322-01
LBH=120/22/13
A2
For steel strips and chains
Szalagos rögzítéshez (domború)
Ellendarab: C1322-00

Art. nr. 8578-00
LBH=45/23/13
A2
Rigid types
Stabil típusok
Ellendarab: C0013-00

Art. nr. 1823-00
LBH=74/32/13
A2
Rigid types
Stabil típusok
Ellendarab: C0018-00

Art. nr. 411-00
LBH=55/23/10
A2
Rigid types
Stabil típusok
Ellendarab: C0013-00

Art. nr. 412-00
LBH=84/22/10
A2
Rigid types
Stabil típusok
Ellendarab: C0013-00

Art. nr. 412-20
LBH=78/23/20
A2
Rigid types
Stabil típusok
Ellendarab: C0013-00

Art. nr. 420-21
LBH=200/46/45
A2
Adjustable types
Állítható típusok
Ellendarab: C0028, C0030

Art. nr. 530 s-00
LBH=100/27/14
A2
Adjustable types
Állítható típusok

Art. nr. 2157-00
LBH=125/33/18
A2
Adjustable types
Állítható típusok
Ellendarab: C0018

Art. nr. 2157-02
LBH=120/33/18
A2
Adjustable types
Állítható típusok
Ellendarab: C0018

Art. nr. 2157-10
LBH=125/33/18
A2
Adjustable types
Állítható típusok
Ellendarab: C0018

Art. nr. 545-05
LBH=143/35/26
A2
Rigid types
Stabil típusok

Art. nr. 756-00
LBH=82/32/21
A2
Rigid types
Stabil típusok

Art. nr. 756-01
LBH=105/32/25
A2
Rigid types
Stabil típusok

Art. nr. 756-02
LBH=92/32/23
A2
Rigid types
Stabil típusok

Art. nr. 541-00
LBH=135/47/22
A2
Rigid types
Stabil típusok
Ellendarab: C0028, C0030

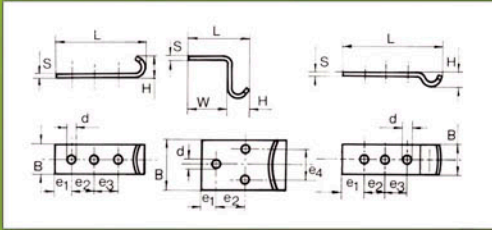

Art. nr. C 9385
 BLSH=28,5/40/3,0/23,5
 A2
 Catch plate
 Békázár ellendarab



Art. nr. C 13-02
 BLSH=13/28/1,5/8
 A2
 Catch plate
 Békázár ellendarab



Art. nr. C 28-04
 BLSH=28/77/3,0/13
 A2
 Catch plate
 Békázár ellendarab



Art. nr. C 18-01
 BLSH=18/45/2,0/10
 A2
 Catch plate
 Békázár ellendarab

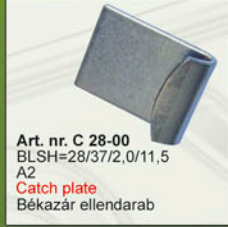

Art. nr. C 28-00
 BLSH=28/37/2,0/11,5
 A2
 Catch plate
 Békázár ellendarab



Art. nr. C 15-00
 BLSH=15/21/2,0/10
 A2
 Catch plate
 Békázár ellendarab



Art. nr. C 15-20
 BLSH=15/50/2,0/12
 A2
 Catch plate
 Békázár ellendarab



Art. nr. C 28-04
 BLSH=28/77/3,0/13
 A2
 Catch plate
 Békázár ellendarab



Art. nr. C 30-00
 BLSH=30/103/3,0/16
 A2
 Catch plate
 Békázár ellendarab



Art. nr. D 18-00
 BLSH=18/23/2,0/10
 A2
 Catch plate
 Békázár ellendarab



Art. nr. D 28-01
 BLSH=28/38/3,0/15
 A2
 Catch plate
 Békázár ellendarab



Art. nr. D 30-01
 BLSH=30/110/3,0/13
 A2
 Catch plate
 Békázár ellendarab

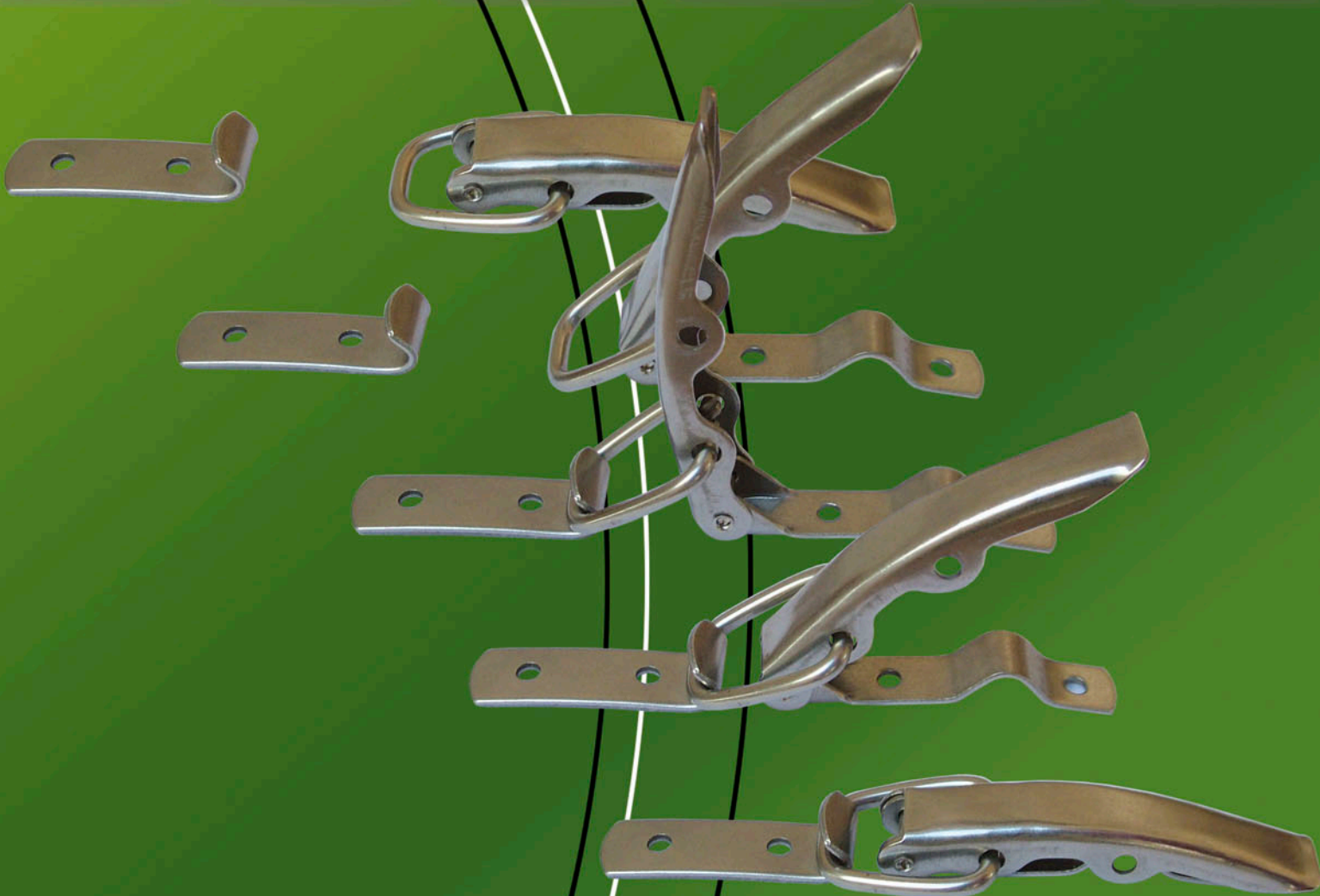

WWW.NONOX.HU



AZ ÖN PARTNERE: